

Penguin Engineering Ltd

Furniss Way, Station Road, Hayling Island, Hampshire PO11 0ED
 Telephone: Hayling Island (023) 9246 5607 - Fax: (023) 9246 1325
 E-mail: info@penguineng.com Web Site: www.penguineng.com

Stainless Steel Sinks & Basins

Price List

January 2012

Code	Description	List £	VAT £	Total £
Basins				
LI.CIL263.5	Cylindrical Tray 26 cms dia.x 3.5 cms deep, blind fixing, mirror finish	38.67	7.73	46.40
LI.CIL26/SD	Cylindrical Basin 26 cms dia.x 18 cms deep, no fixing, mirror finish	56.35	11.27	67.62
LI.CIL26/5	Cylindrical Basin 26 cms dia.x 12.5 cms deep, no fixing, satin finish	44.06	8.81	52.87
LI.CIL303.5	Cylindrical Tray 30 cms dia.x 3.5 cms deep, blind fixing, mirror finish	51.89	10.38	62.27
LI.CIL30/5L	Cylindrical Basin 30 cms dia.x 12.5 cms deep, no fixing, mirror finish	54.93	10.99	65.92
LI.CIL30/SD	Cylindrical Basin 30 cms dia. x 17.5 cms deep, no fixing, mirror finish	61.43	12.29	73.72
LI.CIL30/5	Cylindrical Basin 30 cms dia. x 12.5 cms deep, no fixing, satin finish	49.18	9.84	59.02
LI.CIL353.5	Cylindrical Tray 35 cms dia.x 3.5 cms deep, no fixing, mirror finish	52.46	10.49	62.95
LI.CIL35	Cylindrical Basin 35 cms dia x 20 cms deep, blind fixing, mirror finish	127.03	25.41	152.44
LI.CIL36	Cylindrical Basin 36 cms dia x 18 cms deep, no fixings, mirror finish	69.04	13.81	82.85
LI.CIL41	Cylindrical Basin 41 cms diameter x 20 cms deep, blind fixing, mirror finish	165.66	33.13	198.79
LI.CIL42	Cylindrical Basin 42 cms diameter x 18 cms deep, no fixing, mirror finish	77.42	15.48	92.90
LI.CIL42sb-N	Cylindrical Basin 42 cms diameter x 18 cms deep, no fixing, satin finish	94.25	18.85	113.10
LI.GO34	Pearl shaped basin 34 cms x 34 cms x 15 cms deep, no fixings, mirror finish	88.99	17.80	106.79
LI.OVAL35	Oval basin 35.5 cms x 22 cms x 15 cms deep, blind fixing, mirror finish	107.02	21.40	128.42
LI.OVAL36	Oval basin 35.5 cms x 24 cms x 13 cms deep, no fixing, mirror finish	79.14	15.83	94.97
LI.OVAL38	Oval basin 38 cms x 30.5 cms x 15 cms deep, blind fixing, mirror finish	123.70	24.74	148.44
LI.OVAL45	Oval basin 45 cms x 33 cms x 15 cms deep, no fixings, mirror finish	100.43	20.09	120.52
LI.OVAL45L	Oval basin 45 cms x 33 cms x 15 cms deep, no fixings, mirror finish	103.00	20.60	123.60
LI.SS20	Hemispherical basin 20 cms dia.x 10 cms deep, no fixing, mirror finish	29.98	6.00	35.98
LI.SS20	Hemispherical basin 20 cms dia.x 10 cms deep, no fixing, satin finish	29.98	6.00	35.98
LI.SS26	Hemispherical basin 26 cms dia.x 12.5 cms deep, no fixing, mirror finish	38.75	7.75	46.50
LI.SS26/5	Hemispherical basin 26 cms dia x 12.5 cms deep, no fixing, satin finish	38.75	7.75	46.50
LI.SS30/SD	Hemispherical basin 30 cms dia. x 15 cms deep, no fixing, mirror finish	43.46	8.69	52.15
LI.SS36	Hemispherical basin 35 cms dia x 15 cms deep, blind fixing, mirror finish	53.94	10.79	64.73
Single Inset Sinks				
LI.30.14.15	30 cms x 14 cms x 15 cms centre hole, blind fixing, mirror finish	89.58	17.92	107.50
LI.30.14.18	30 cms x 14 cms x 18 cms centre hole, blind fixing, mirror finish	101.03	20.21	121.24
LI.30.23.15	30 cms x 23 cms x 15 cms centre hole, blind fixing, mirror finish	105.87	21.17	127.04
LI.30.23.20	30 cms x 23 cms x 20 cms centre hole, blind fixing, mirror finish	110.14	22.03	132.17
LI.30.24.15	30 cms x 24 cms x 15 cms centre hole, no fixing, satin finish	56.06	11.21	67.27
LI.30.24.20	30 cms x 24 cms x 20 cms centre hole, no fixing, satin finish	62.92	12.58	75.50
LI.30.32.15	30 cms x 32 cms x 15 cms centre hole, blind fixing, mirror finish	112.96	22.59	135.55
LI.30.32.20	30 cms x 32 cms x 20 cms centre hole, blind fixing, mirror finish	120.85	24.17	145.02
LI.30.33.15	30 cms x 33 cms x 15 cms centre hole, no fixing, satin finish	65.67	13.13	78.80
LI.30.33.20	30 cms x 33 cms x 20 cms centre hole, no fixing, satin finish	74.11	14.82	88.93
LI.33.23.18	33 cms x 23.5 cms x 18 cms centre hole, blind fixing, mirror finish	117.99	23.60	141.59
LI.33.33.18	33 cms x 33 cms x 18 cms centre hole, blind fixing, mirror finish	121.85	24.37	146.22
LI.33.33.25	33 cms x 33 cms x 25 cms corner hole, blind fixing, mirror finish	147.22	29.44	176.66
LI.34.29.20L	34 cms x 29 cms x 20 cms corner hole, blind fixing, mirror finish 'B' Flange	140.53	28.11	168.64
LI.34.29.20R	34 cms x 29 cms x 20 cms corner hole, blind fixing, mirror finish 'B' Flange	140.53	28.11	168.64
Flat Flange Single Inset Sinks				
LI.30.23.15-C	30 cms x 23 cms x 15 cms centre hole, no fixing, mirror finish	98.58	19.72	118.30
LI.34.29.20C/L	34 cms x 29 cms x 20 cms corner hole, blind fixing, mirror finish 'C' Flange	112.24	22.45	134.69
LI.34.29.20C/R	34 cms x 29 cms x 20 cms corner hole, blind fixing, mirror finish 'C' Flange	112.24	22.45	134.69
LI.33.33.18C	33 cms x 33 cms x 18 cms centre hole, no fixing, mirror finish (overall 36cm X 36cm)	111.70	22.34	134.04
LI.33.33.18bC	33 cms x 33 cms x 18 cms centre hole, no fixing, satin finish (overall 36cm X 36cm)	86.90	17.38	104.28
LI.33.52.20	33 cms x 52 cms x 20 cms, no fixing, satin finish (overall 35.6cm X 54.6cm)	120.17	24.03	144.20
LI.35.29.20CL	35 cms x 29 cms x 20cms, no fixing, satin finish #	82.50	16.50	99.00
LI.40.34.20C/WD	40 cms x 34 cms x 20 cms, centre waste disposal hole	141.21	28.24	169.45
LI.40.50.30 L	40 cms x 50 cms x 30 cms, no fixing, mirror finish (overall 44cm X 54cm)#	219.30	43.86	263.16

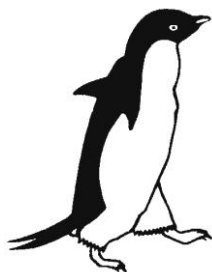

Penguin Engineering Ltd

Furniss Way, Station Road, Hayling Island, Hampshire PO11 0ED
 Telephone: Hayling Island (023) 9246 5607 - Fax: (023) 9246 1325
 E-mail: info@penguineng.com Web Site: www.penguineng.com

Double Sinks

Price List

January 2012

Code	Description	List £	VAT £	Total £
Mirror Finish Double Inset Sinks				
LV.30.32.14.15A	30 x 32 x 15 + 30 x 14 x 15 A flange, six blind fixings	279.54	55.91	335.45
LV.30.32.23.15A	30 x 32 x 15 + 30 x 23 x 15 A flange, six blind fixings	298.63	59.73	358.36
LV.30.32.23.20A	30 x 32 x 20 + 30 x 23 x 20 A flange, six blind fixings	309.14	61.83	370.97
LV.30.32.32.15A	30 x 32 x 15 + 30 x 32 x 15 A flange, six blind fixings	317.51	63.50	381.01
LV.30.32.32.20A	30 x 32 x 20 + 30 x 32 x 20 A flange, six blind fixings	331.66	66.33	397.99
LV.32.30.30.15A	32 x 30 x 15 + 32 x 30 x 15 A flange, six blind fixings	317.51	63.50	381.01
LV.32.30.30.20A	32 x 30 x 20 + 32 x 30 x 20 A flange, six blind fixings	331.66	66.33	397.99
LV.33.33.33.20D	33 x 33 x 20 + 33 x 33 x 20 D flange, six blind fixings	402.83	80.57	483.40
Mirror Finish Double Under Surface Sinks				
LV.30.32.14.15C	30 x 32 x 15 + 30 x 14 x 15 with C flat flange	259.97	51.99	311.96
LV.30.32.23.20C	30 x 32 x 20 + 30 x 23 x 20 with C flat flange	289.74	57.95	347.69
LV.33.33.23.16CL	33 x 33 x 16 + 33 x 23 x 16 with C flat flange	281.15	56.23	337.38
LV.33.33.23.16CR	33 x 33 x 16 + 33 x 23 x 16 with C flat flange	281.15	56.23	337.38
LV.33.33.23.20CL	33 x 33 x 20 + 33 x 23 x 20 with C flat flange	301.50	60.30	361.80
LV.33.33.23.20CR	33 x 33 x 20 + 33 x 23 x 20 with C flat flange	301.50	60.30	361.80
LV.33.33.33.20C	33 x 33 x 20 + 33 x 33 x 20 with C flat flange	325.41	65.08	390.49
LV.29.34.34.20C	29 x 34 x 20 + 29 x 34 x 20 with C flat flange	300.98	60.20	361.18
LV.34.29.29.20C	34 x 29 x 20 + 34 x 29 x 20 with C flat flange	300.98	60.20	361.18
LV.40.34.34.25C	40 x 34 x 25 + 40 x 34 x 25 with C flat flange (overall 72cm X 43cm)#	487.53	97.51	585.04
Satin Finish Double Under Surface Sinks				
LV.30.32.14.15CB	30 x 32 x 15 + 30 x 14 x 15 with C flat flange	201.37	40.27	241.64
LV.30.33.15.15C	30 x 33 x 15 + 30 x 15 x 15 with C flange	163.31	32.66	195.97
LV.30.33.24.15C	30 x 33 x 15 + 30 x 24 x 15 with C flange	164.80	32.96	197.76
LV.30.33.24.20C	30 x 33 x 20 + 30 x 24 x 20 with C flange	188.83	37.77	226.60
LV.33.33.23.16b R & L	33 x 33 x 16 + 33 x 23 x 16 with C flange	207.03	41.41	248.44
LV.33.33.23.20b R & L	33 x 33 x 20 + 33 x 23 x 20 with C flange	215.44	43.09	258.53
LV.33.33.33.20b C	33 x 33 x 20 + 33 x 33 x 20 with C flange	231.75	46.35	278.10
LV.35.29.29.20C	35 x 29 x 20 + 29 x 29 x 20 with C flange	236.04	47.21	283.25

Suffix R defines that the larger sink is to the right, suffix L to the left, (waste holes at the rear).
 See the sketch sheets for more information on dimensions, layouts, flange and waste detail.

Above dimensions are internal. See sketch pages for more detail on dimensions, layouts and flange details, and compatible wastes.

Sink & basin bodies are formed from 1 mm thick 18/8 grade stainless steel & either polished or satin finished internally and on the flange top.

'Blind fixing' means that unseen captive nuts are welded under the flange of inset sinks which are used with the studs and nuts supplied to hold the sinks or basin neatly onto the work surface, on a removable soft mastic

'No fixing' means the unit is bonded in using a suitable bonding agent.

– no diagram

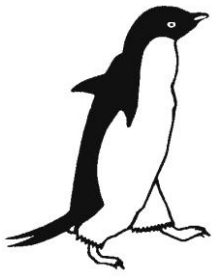

Penguin Engineering Ltd

Furniss Way, Station Road, Hayling Island, Hampshire PO11 0ED
 Telephone: Hayling Island (023) 9246 5607 - Fax: (023) 9246 1325
 E-mail: info@penguineng.com Web Site: www.penguineng.com

S/S SINKS

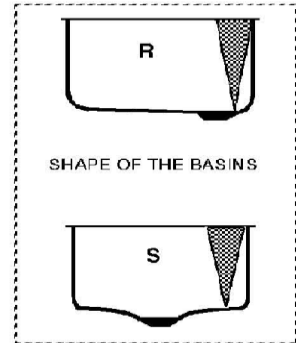
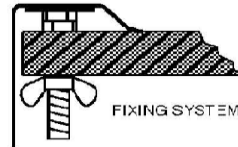
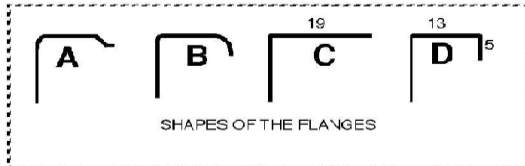

BASINS

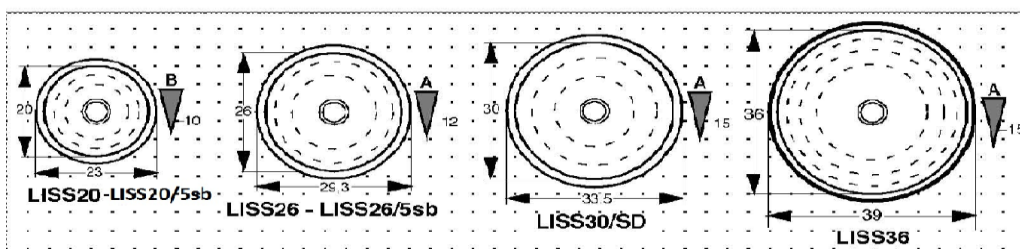
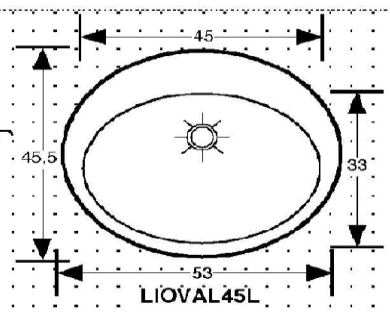
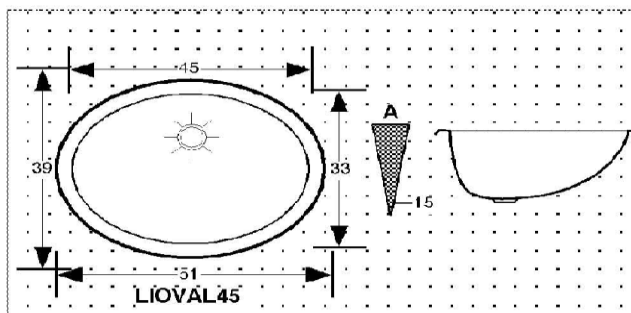
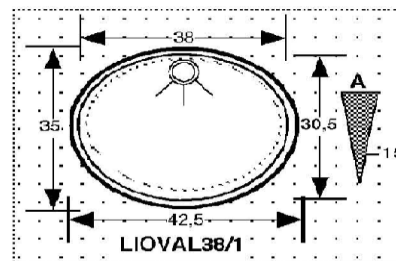
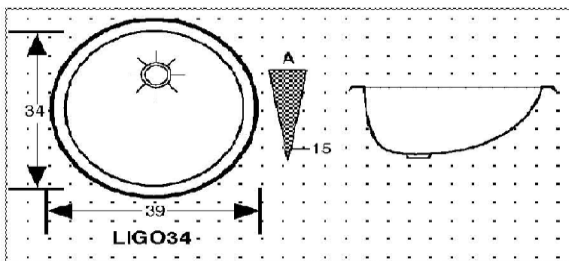
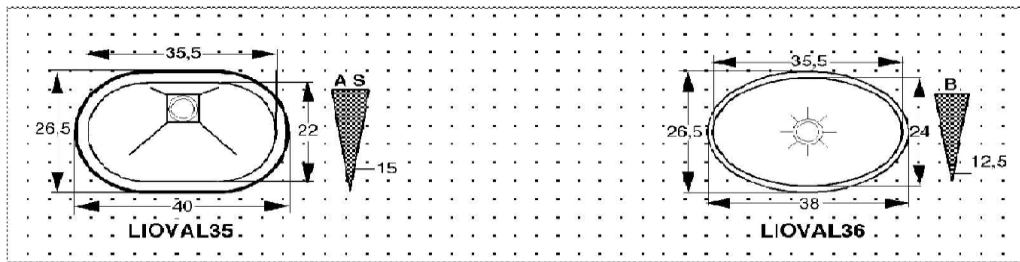



Penguin Engineering Ltd

Furniss Way, Station Road, Hayling Island, Hampshire PO11 0ED
 Telephone: Hayling Island (023) 9246 5607 - Fax: (023) 9246 1325
 E-mail: info@penguineng.com Web Site: www.penguineng.com

CYLINDRICAL SERIES

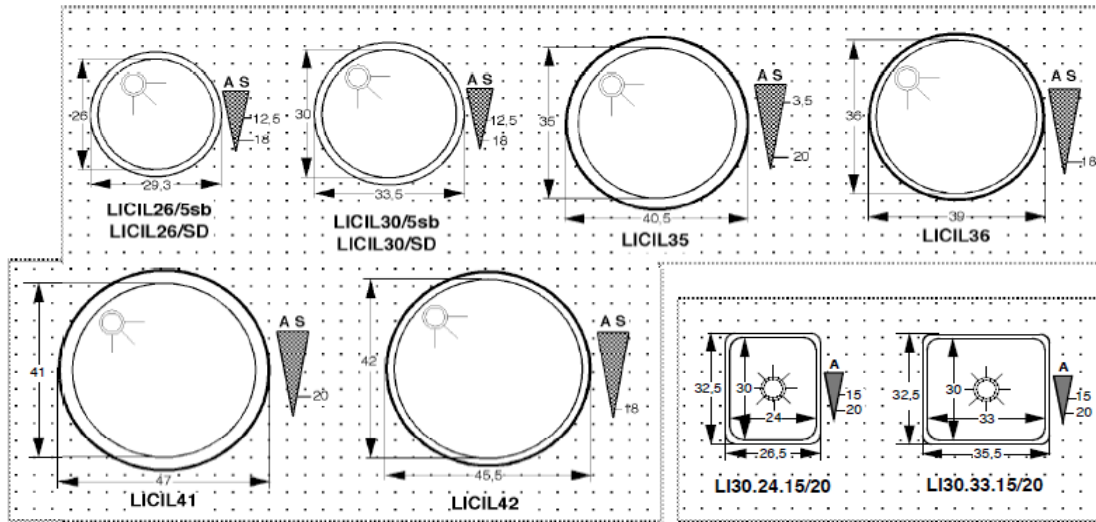

RECTANGULAR

serie 30

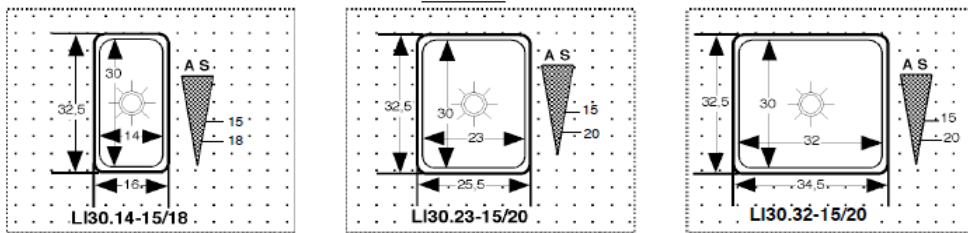

serie 33

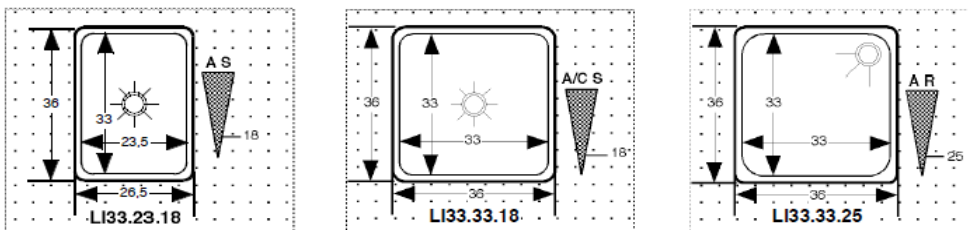

serie 34

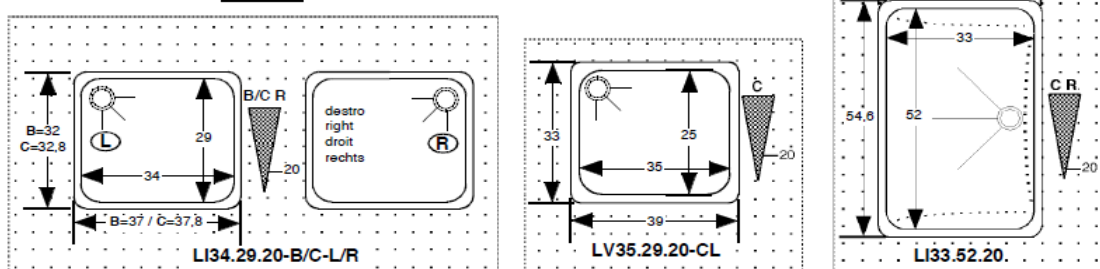



Penguin Engineering Ltd

Furniss Way, Station Road, Hayling Island, Hampshire PO11 0ED
 Telephone: Hayling Island (023) 9246 5607 - Fax: (023) 9246 1325
 E-mail: info@penguineng.com Web Site: www.penguineng.com

DOUBLE SINKS

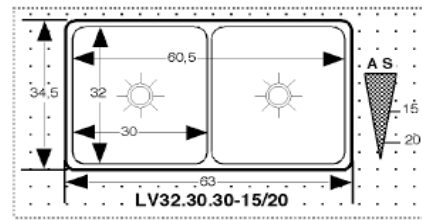
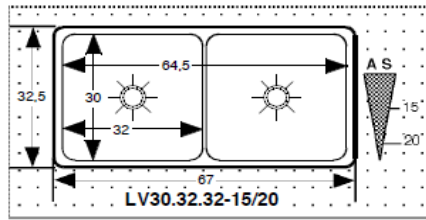
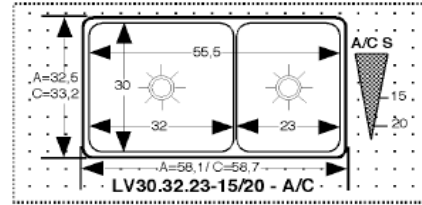
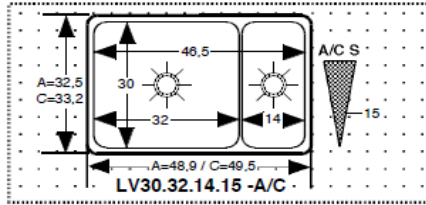

flat flange

